



CALONOX SIGHT

Instruction manual

FOREWORD

Dear Customer,
we wish you a great deal of enjoyment and every success with your new Leica product.

Please read this manual to familiarize yourself with the full scope of functions your product has to offer.

Please use this product only as described in this manual. Only then can safe and easy operation be guaranteed.

All the information you need about your product is available anytime at:

<https://www.leica-calnox.com>

Your Leica Camera AG

Please read the chapters “Safety Remarks” and “Important Information” before using the product for the first time. Knowledge of the content will prevent inadvertent damage to the product, possible injuries and other risks.

SCOPE OF DELIVERY

The standard scope of delivery* contains the following:

- Calnox Sight
- Cordura case
- Charging cable
- Carry strap
- Quick Start Guide
- Lens cleaning cloth
- Lens cap with safety cord
- Rubber eyecup
- Test certificate

REPLACEMENT PARTS / ACCESSORIES

Contact Leica Customer Care or your specialist Leica retailer for details on the latest replacement parts / accessory range:

<https://en.leica-camera.com/Stores-Dealers/Leica-dealer-locator>

*The actual scope of delivery may vary depending on model.

LEGAL INFORMATION

LEGAL INFORMATION ABOUT THIS MANUAL

COPYRIGHT

All rights reserved.

All text, images and graphics are subject to copyright and other laws to protect intellectual property. They must not be copied, modified or used for any purpose including trade purposes.

TECHNICAL DATA

Product changes with regards to the product or services may have occurred after the editorial deadline. The manufacturer reserves the right to effect structural or shape changes, color deviations and changes to the scope of delivery or service, where these changes or deviations are reasonably acceptable for the customer, while taking into consideration the interests of Leica Camera AG. In that respect, Leica Camera AG reserves the right to changes and errors. The images in this manual may depict accessory, special features or other items that are not part of the standard scope of delivery or service. Some pages may contain model types and services, which are not offered in specific countries.

BRANDS AND LOGOS

The brand names and logos used in this documented are protected trademarks. These brands or logos must not be used without prior approval by Leica Camera AG.

LICENSE RIGHTS

Leica Camera AG intends to provide you with innovative and informative documentation. Due to the amount of creativity that has gone into its design, we ask for your understanding that Leica Camera AG must protect its intellectual property, including patents, trademarks and copyrights, and that possession of the documentation does not infer any licensing rights of the intellectual property of Leica Camera AG.

IMPORTANT NOTES REGARDING THE USE OF THERMAL IMAGING CAMERAS

LEGAL RESTRICTIONS ON USE

In Germany

- The use of thermal imaging cameras in the form of attachments is subject to weapons or hunting permits and other restrictions, which may differ from region to region. Please make sure to request relevant information about their use from local authorities.

Outside of Germany

- The use of thermal imaging devices and associated technologies may be restricted in some countries or regions. You should therefore contact your travel agent or the embassy of your destination country for relevant information beforehand. Violations will be prosecuted by local authorities.

IMPORTANT NOTES REGARDING THE USE OF WLAN/BLUETOOTH®

(CONNECTING TO THE LEICA CALONOX APP)

Please see p. 30 for instructions how to connect to the Leica Calonox app.

- Appropriate measures must be taken to ensure security and protect against disruptions to the systems in place where devices or computer systems are in use that require more stringent security than WLAN devices.
- Leica Camera AG shall not accept liability for damages arising from the use of the camera for purposes other than as a WLAN device.
- It is assumed that the WLAN function will be used in countries where this camera is sold. There may be a risk of breaching statutory wireless communication regulations when using the camera in other countries. Leica Camera AG shall not accept liability for such breaches.
- Please note that there is a risk of unauthorized third party interception of wirelessly communicated data. We highly recommend that you activate encryption in the wireless access point settings to ensure data safety.
- Avoid using the camera in areas where it can be exposed to magnetic fields, static electricity or other interferences, e.g. near a microwave oven. RF transmissions may otherwise not reach the camera.
- Using the camera near devices like microwave ovens or wireless phones that use the 2.4 GHz RF band may negatively affect the performance of both devices.
- Do not attempt to connect to wireless networks you are not authorized to use.
- The device will automatically search for wireless networks, once the WLAN function is enabled. A list, including networks you are not authorized to access, will be displayed (SSID: Network identifier for a WLAN network). Do not attempt to connect to such a network, as this could be construed as unauthorized access.
- We recommend disabling the WLAN function while on an aircraft.

REGULATORY INFORMATION

You will find the manufacturing date of your product on the stickers on the packaging. The date format is year/month/day.

CE MARK

The CE mark on our products documents compliance with the fundamental requirements of applicable EU guidelines.

English

Declaration of Conformity (DoC)

Hereby, "Leica Camera AG" declares that this product is in compliance with the essential requirements and other relevant provisions of Directive 2014/53/EU.

Customers can download a copy of the original DoC to our Radio Equipment products from our DoC server:

www.cert.leica-camera.com

Please contact The Leica Camera AG Product Support in case of any further questions: Am Leitz-Park 5, 35578 Wetzlar, Germany

Depending on product (see technical data)

Type	Frequency band (center frequency)	Maximum output (dBm E.I.R.P.)
WLAN	2412-2462/5180-5240 MHz/ 5260-5320/5500-5700 MHz	20
Bluetooth® Wireless Technology	2402-2480 MHz	20

DISPOSAL OF ELECTRICAL AND ELECTRONIC EQUIPMENT

(Applies within the EU and for other European countries with active waste separation policies.)



This device contains electric and/or electronic components which must not be disposed of in general household waste. Instead, it should be disposed of at a recycling collection point provided by your local authority.

This service is free of charge. Any standard or rechargeable batteries used in this device must be removed and disposed of separately in accordance with local regulations.

Please contact your local authorities, waste disposal collection point or the retailer, from whom you purchased the device for more information on correct waste disposal.

SAFETY REMARKS

GENERAL INFORMATION

- Do not use your device in the immediate vicinity of devices with powerful magnetic, electrostatic or electromagnetic fields (e.g. induction ovens, microwave ovens, television sets or computer screens, video game consoles, cell phones, broadcasting equipment). Their electromagnetic fields can interfere with recordings.
- Image recording may be affected if you place the device on a television set or operate it in close proximity of a TV or near a cell phone.
- Strong magnetic fields, e.g. from speakers or large electric motors can damage the stored picture data or disrupt recording.
- Do not use the device in the immediate vicinity of radio transmitters or high-voltage power lines. Their electromagnetic fields may interfere with recordings.
- Do not attempt to remove parts of the housing (covers) yourself. Repairs must be done at authorized service centers only.
- The device must not come into contact with insect repellent sprays or other aggressive chemicals. Petroleum spirit, thinner and alcohol must not be used for cleaning. Some chemicals and liquids may damage the device housing or its surface coating.
- Keep the device out of the reach of small children.
- Do not use the device while walking. You might trip and fall.
- Do not attempt to disassemble or modify the device; exposing the internal electronics may cause damage, injury or electric shock.

EYEPIECE

- An eyepiece can have the effect of a magnifying glass when exposed to direct frontal sunlight. The device must therefore be protected against extended exposure to direct sunlight. Storing the device in the shade or ideally in its case will help prevent damage to the device interior.

SENSOR

- Cosmic radiation (e.g. during flights) may cause pixel defects.

CARRY STRAP

- Once you have attached the carry strap, please make sure that the clips are mounted correctly to prevent the device falling.
- The carry strap is usually made of very robust material. You should therefore keep it out of the reach of children. A carry strap is not a toy and poses a strangulation risk.
- The carry strap should only be used for their intended purpose. Any other use poses the risk of injury and may possibly result in damage to the carry strap and is therefore not permitted.
- Carry straps should also not be used for cameras/binoculars during sports activities that pose a risk of entanglement (e.g. when mountain climbing and similar outdoor activities).

IMPORTANT INFORMATION

- Do not attempt to take the device apart yourself. Repairs must only be carried out in authorized workshops.
- Do not touch the glass surfaces with your fingers, especially if you have previously applied hand cream, insect repellent, etc. These substances may contain chemicals that damage or destroy the coatings on the glass surfaces.
- Protect the device against any kind of shocks that are not caused by the weapon.
- Make a note of the serial number of your device, as this information will be extremely important in case of loss.

WARRANTY

In addition to your statutory warranty rights from your dealer, Leica Camera AG offers a 3-year warranty for this Leica product in accordance with the conditions started below. The Leica warranty does not impact on any statutory consumer rights in accordance with relevant national law or any consumer rights vis-a-vis the retailer arising from the purchase contract concluded between them.

WARRANTY CONDITIONS

By purchasing this Leica thermal imaging camera, you have acquired a product that is manufactured in compliance with special quality standards, and which was thoroughly tested at each individual production step by experienced specialists. Our three-year warranty for this product commences on the date of sale by an authorized retailer under the following conditions:

1. In case of a complaint due to a manufacturing fault, we will assume all material costs during the warranty period. We shall decide at our own discretion to repair the faulty product, to replace faulty parts or to replace the entire product with a faultless product of the same type. All other claims of any kind and on whatever legal basis shall not be accepted in connection with this warranty.
2. Wear parts like eyecups, leather details, armoring, carry straps and accessories are exempt from the warranty. The same applies for surface damage.
3. Any warranty claims become void if the defect in question is a result of improper handling – which also includes the use of third-party accessories – or if the product was manipulated by unauthorized persons or workshops or if the serial number of the product was rendered illegible.
4. Warranty claims can be submitted only in conjunction with the original proof of purchase – complete with the date of purchase, as well as the address and signature of an authorized retailer.

5. In case of a warranty claim, please send the Leica product, the original proof of purchase and a description of the fault to Leica Camera AG Customer Care or a Leica regional subsidiary.

Leica Calonox models come with splash water protection coating (IPX5).

The device was tested under controlled laboratory conditions and is classed as IPX5 in accordance with DIN EN 60529. Please note: the protection coating is not permanent and will diminish over time. The warranty does not cover liquid damage. Any attempt to open the device by an unauthorized retailer or service partner will result in the immediate expiration of the warranty.

PICK-UP SERVICE FOR REPAIR SUBMISSIONS

(Applies for EU only)

We will organize the shipping of your device to our Customer Care department if you should notice a problem with your device during the warranty period. Please contact our service hotline to make the necessary arrangements (+49 (0)6441 2080 189). Our pick-up service will collect your Leica product at the agreed time from your premises free of charge and transport it to our Customer Care location for evaluation.













Contact: en.leica-camera.com/Contact

LEICA HUNTING ETHICS

HUNTING ETHICS AND LEICA THERMAL IMAGING CAMERAS

- We will only hunt wild boar and predators at night.
- We will hunt wild boar predominantly in areas of agricultural damage, but not in their habitats and refuge areas in the forest.
- We use the technology for monitoring and documentation purposes, and not just for detection.
- We want to improve the hunt by zeroing in on the game better and more easily to ensure a clean kill.
- We use these new dynamics driven by technology for exciting hunting experiences while we track the game, and also help prevent damage caused by game.

TABLE OF CONTENT

FOREWORD	2	CALIBRATING	21
SCOPE OF DELIVERY	2	FULL CALIBRATION.....	21
REPLACEMENT PARTS / ACCESSORIES	2	QUICK CALIBRATION	21
LEGAL INFORMATION	3	FOCUSING	21
LEGAL INFORMATION ABOUT THIS MANUAL.....	3	BUTTON FUNCTION OVERVIEW	22
IMPORTANT NOTES REGARDING THE USE OF THERMAL IMAGING CAMERAS	4	ICONS MENU	23
IMPORTANT NOTES REGARDING THE USE OF WLAN/BLUETOOTH®.....	4	MENU CONTROL	23
REGULATORY INFORMATION	5	BRIGHTNESS 	23
SAFETY REMARKS	6	COLOR MODE 	23
IMPORTANT INFORMATION	7	CONTRAST 	23
WARRANTY.....	8	LIST MENU	24
LEICA HUNTING ETHICS	9	MENU CONTROL	24
TABLE OF CONTENT	10	VIDEO OUTPUT - 	25
PART DESIGNATIONS	12	BLUETOOTH - 	25
DISPLAYS.....	14	"FOG AND RAIN" MODE - 	25
PREPARATION	16	HANDHELD MODE - 	25
ATTACHING THE CARRY STRAP	16	USER PROFILES - 	26
ATTACHING THE SAFETY CORD.....	16	CORRECTING PIXEL ERRORS - 	27
CHARGING THE BATTERY.....	17	CORRECTING THE RETICLE - 	28
ACCESSORY MOUNTING.....	17	SHOW SYSTEM INFORMATION - 	28
MOUNTING THE EYECUP.....	18	RESET TO FACTORY SETTINGS - 	29
OPERATION	19	PROCEDURE IN CASE OF MALFUNCTION	29
SWITCHING THE DEVICE ON/OFF.....	19	LEICA CALONOX APP.....	30
POWER SAVE MODE (STANDBY MODE).....	19	CARE/CLEANING.....	31
CALIBRATION	20	TECHNICAL DATA.....	32
SELECTING A MODE	20	LEICA CUSTOMER CARE.....	34

Definition of the various categories of information found in this manual**Note**

- Additional information

Important

- Non-compliance may result in damage to the device and accessories

Attention

- Non-compliance may result in personal injury

PART DESIGNATIONS

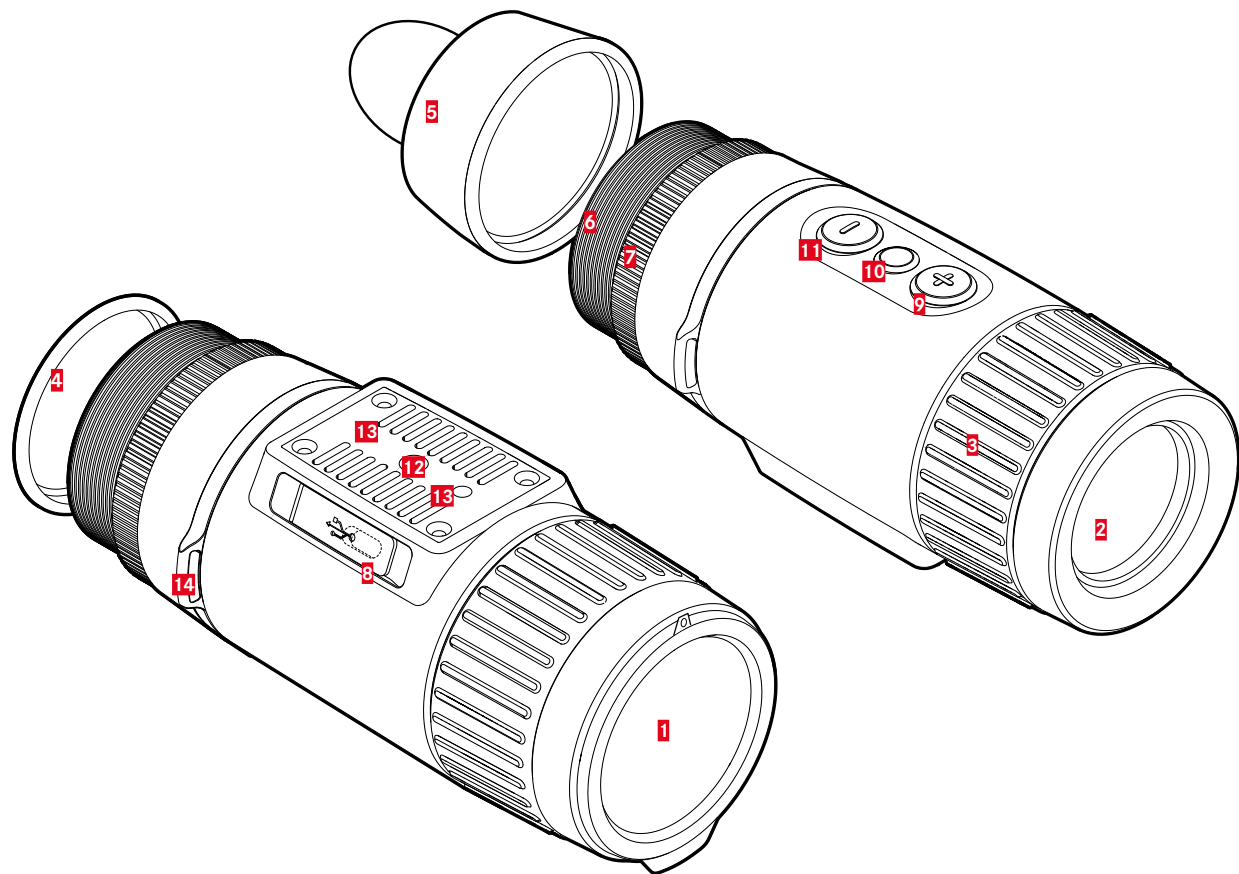

- 1 Lens cap**
 - Lens protection
 - While carrying out complete calibration
- 2 Front lens**
 - Germanium lens
 - Heat signatures is forwarded to the sensor
- 3 Focus ring**
 - Focusing to the relevant distance
- 4 Eyepiece cap**
- 5 Eyecup**
 - Prevents lateral light incidence
- 6 Thread**
 - Mounting of the accessory adapter
 - Mounting the eyecup
- 7 Locking ring**
 - Securing of the accessory adapter
- 8 USB interface (USB-C)**
 - Picture transmission (PAL)
 - external power supply
- 9 [+] button***
 - On/Off
 - Standby mode
 - Menu navigation
- 10 Menu selection button***
 - Accessing the menus
 - Storing of settings
- 11 [-] button***
 - Menu navigation
 - Calibration
- 12 Tripod thread**
 - A 1/4 DIN 4503 (1/4")
- 13 Tripod thread**
 - M5 standard thread
- 14 Strap lugs**

*See p. 22 for a detailed overview of the button functions.

DISPLAYS

OBSERVATION MODE

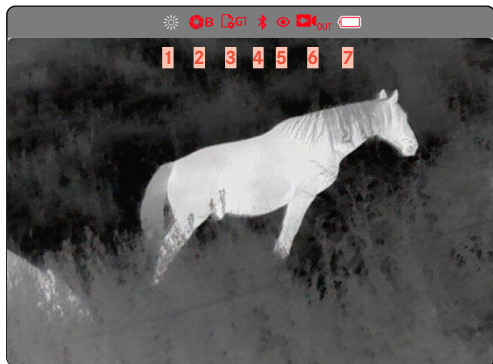

ICONS MENU

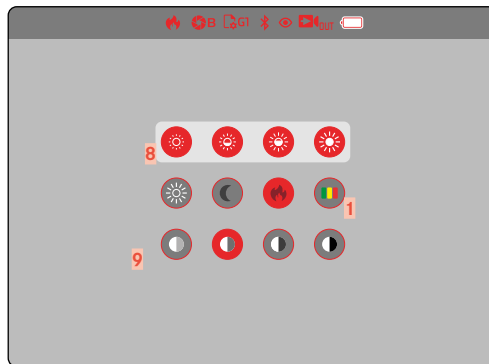

LIST MENU

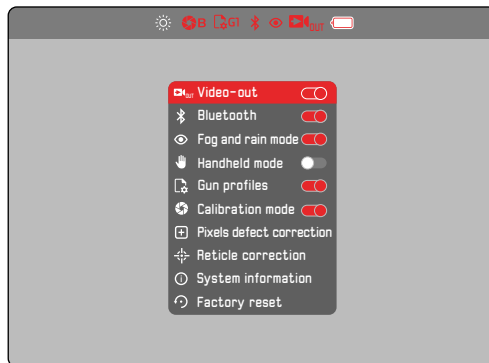

1 Color mode

 - White Hot (warm appears white)

 - Black Hot (warm appears black)

 - Red Hot (warm appears red)

 - Rainbow (multicolored)

2 Calibration mode

A (Automatic)/**B** (Background)/**M** (Manual)

3 User Profiles

4 Bluetooth

5 “Fog and rain” mode

6 Video-out

7 Battery capacity

The battery charge status is displayed in the header line.

8 Brightness

4 selectable increments

9 Contrast

4 selectable increments

PREPARATION

ATTACHING THE CARRY STRAP

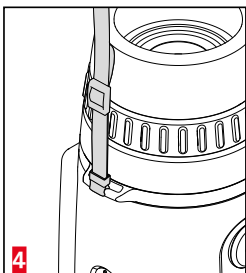
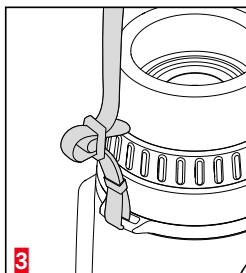
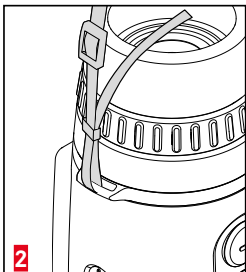
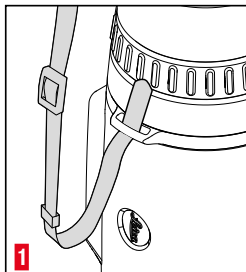

ATTACHING THE SAFETY CORD

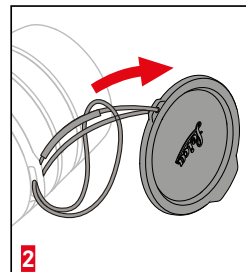
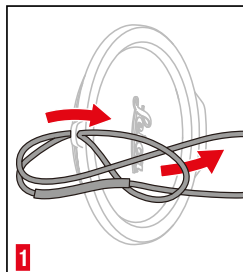

Important

- Once you have attached the carry strap, please make sure that the clips are mounted correctly to prevent the device falling.

CHARGING THE BATTERY

A lithium-ion rechargeable battery supplies the device with power. The battery charge status is displayed in the header line.

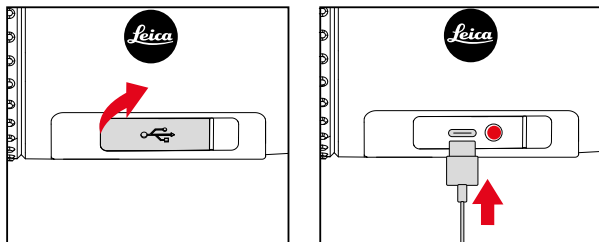

- ▶ Grab and pull the left end of the cover cap
- ▶ Insert the USB cable (USB-C)
- ▶ Connect the other end of the USB cable to a suitable power adapter (min. 1.5 A/5 V input for optimal charging time)
 - The status LED indicates a correct charging process. The status LED will switch from red to green, once the battery is fully charged.
 - The icon ⚡ will be displayed in the header line next to the battery icon while the battery is charging.

ACCESSORY MOUNTING

A relevant adapter will be needed if the device is to be mounted on the weapon in conjunction with a rifle scope. Leica generally recommends the use of adapters by the following manufacturers:

- Recknagel
- Rusan

The following description may vary depending on manufacturer and model. Please read the instructions provided with your adapter before use.

- ▶ Unscrew the eyepiece cap and store it in a safe place
- ▶ Screw on the adapter onto the Calonox to the stop
- ▶ Rotate the attached adapter back until the locking mechanism is in the desired position
- ▶ Hand-tighten the locking ring against the adapter
- ▶ Slide the adapter with the attached Calonox onto the lens area of the rifle scope to the stop
 - Make sure that the adapter slides smoothly. It must have even contact all around.
- ▶ Actuate the clamping lever on the rifle scope (comply with manufacturer instructions)
 - The adapter and Calonox may have to be aligned to ensure that the display and reticle are not at an angle to each other.

Once mounted, the screen of the Calonox must be aligned with the reticle of the rifle scope, see p. 28.

Attention

- Make sure the weapon is not loaded before doing any work and that the safety is on.

MOUNTING THE EYECUP (USE AS HANDHELD DEVICE)

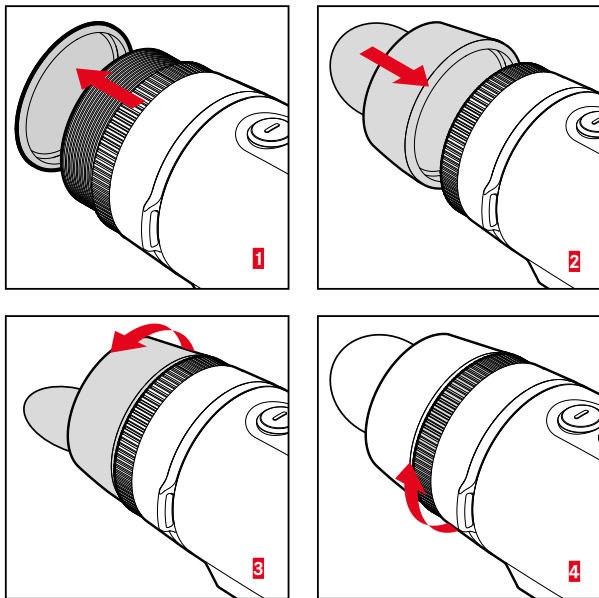

The eyecup supplied must be attached if the device is to be used as a handheld/monocular (without the rifle scope).

- ▶ Unscrew the eyepiece cap and store it in a safe place
 - The locking ring must remain on the device.
- ▶ Set the eyecup with side light shield to the right position
- ▶ Hand-tighten the locking ring to fix the position
 - Don't use too much force!

OPERATION

SWITCHING THE DEVICE ON/OFF

SWITCHING ON

- ▶ Press and hold the **[+]** button, until the 'Leica' logo appears on screen
 - This switches on the device.

Note

- The device will not automatically power down.

SWITCHING OFF

- ▶ Press and hold the **[+]** button
 - A countdown appears on screen, which counts down the final three seconds.
- ▶ Press and hold the **[+]** button until the countdown is complete
 - The device switches off.

Note

- The device will not automatically power down.

POWER SAVE MODE (STANDBY MODE)

- ▶ Press the **[+]** button briefly
 - The device switches to standby mode. The power save icon appears.



Note

- In standby mode, the device can be activated quickly at any time by pressing the **[+]** button.

CALIBRATION

Calibrations should be done regularly for optimal display performance. There are two types of calibration (quick calibration and full calibration). The calibration to choose depends on the set operating mode.

Three operating modes are available:

	Function	Press the [-] button
A	<u>Automatic recalibration</u> The device recalibrates automatically during operation.	Quick calibration
M	<u>Manual calibration</u> Quick calibration can be triggered manually whenever necessary. The settings remain until the next calibration is started.	Quick calibration
B	The device is fully calibrated each time.	Full calibration

Note

- The lens cap must be mounted for full calibration.

SELECTING A MODE

- ▶ Press and hold the menu selection button
 - The list menu appears.
- ▶ Press the **[+]** and **[-]** buttons to navigate to the menu item **Calibration mode**
- ▶ Press the menu selection button repeatedly, until the desired setting is displayed
- ▶ Press and hold the menu selection button
 - The setting will now be saved. The device returns to observation mode.

Note

- The operating modes M or B are recommended where the device is used as an accessory mount.

CALIBRATING

FULL CALIBRATION

In this calibration mode, the device is fully recalibrated. That makes it much more effective and suitable for e.g. the removal of annoying afterimages. These effects can be more or less severe, depending on circumstances. This type of calibration is the most exact.

- ▶ Close the lens cap
- ▶ Press the [-] button

QUICK CALIBRATION

This type of calibration is done significantly faster and doesn't require a closing of the lens cap. Afterimages may remain.

- ▶ Press the [-] button

FOCUSING

Use the focus ring to sharpen the image.

- ▶ Select an image section
- ▶ Turn the focus ring to sharpen the desired subject elements
 - The entire depth area is run through with a quarter turn (90°) of the focus ring.

BUTTON FUNCTION OVERVIEW

		Observation mode	Menu	Correction mode
[+] button	Press the <u>briefly</u>	Standby/Wakeup	To the right/up	To the right/up
	Press and hold	On/Off	–	To the right/up (quick)
Menu selection button	Press the <u>briefly</u>	Access icons menu	Setting in the submenu/ Save	Switch active axis (<u>Reticle correction</u>)
	Press and hold	Access list menu	Save/Exit menu	Save and exit
[-] button	Press the <u>briefly</u>	Calibration	To the left/down	To the left/down
	Press and hold	–	–	To the left/down (quick)

ICONS MENU

MENU CONTROL

Accessing the icons menu

- ▶ Press the menu selection button briefly
 - The icons menu appears.
 - The device will automatically return to observation mode after ca. 4 s of inactivity.

Accessing a menu item

- ▶ Press the **[+]** and **[-]** buttons to navigate to the desired menu item
- ▶ Press the menu selection button briefly
 - The menu option can now be set.

Changing a setting

- ▶ Press the **[+]** and **[-]** buttons to navigate to the desired setting
- ▶ Press the menu selection button briefly
 - The setting will now be saved. The display returns to the icons menu.

Exiting the icons menu

- ▶ Press and hold the menu selection button
 - The device returns to observation mode.

or

- ▶ Wait approx. 4 s
 - The device will automatically return to observation mode after ca. 4 s of inactivity.

BRIGHTNESS

Brightness can be set to four different levels.

COLOR MODE

There are four color modes to choose from.

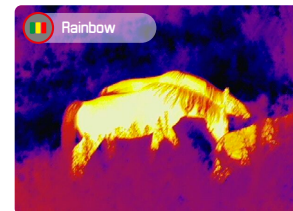
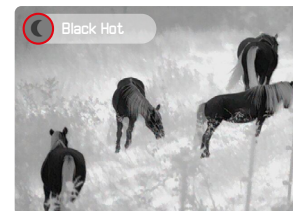

CONTRAST

Image contrast can be set to four different levels.

LIST MENU

The list menu consists of one menu page with a total of 10 settings.

MENU CONTROL

Accessing the list menu

- ▶ Press and hold the menu selection button
 - The list menu appears.
 - The device will automatically return to observation mode after ca. 10 s of inactivity.

Exiting the list menu

- ▶ Press and hold the menu selection button
 - The device returns to observation mode.
- or
- ▶ Wait approx. 10 s
 - The device will automatically return to observation mode after ca. 10 s of inactivity.

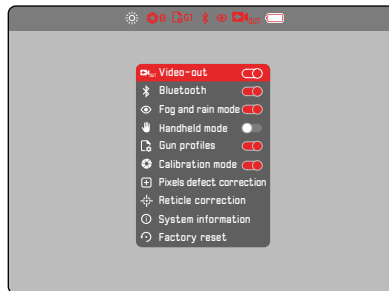

Activating/deactivating an option

- ▶ Press the **[+]** and **[-]** buttons to navigate to the desired menu item
- ▶ Press the menu selection button briefly

Accessing a menu item

- ▶ Press the **[+]** and **[-]** buttons to navigate to the desired menu item
- ▶ Press the menu selection button briefly

VIDEO OUTPUT -

Calonox allows an output of the screen image to an external screen.

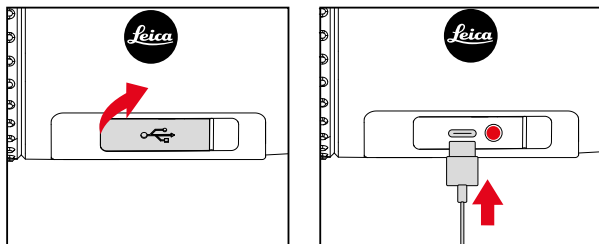

- ▶ Grab and pull the left end of the cover cap
- ▶ Insert the USB cable (USB-C)
- ▶ Connect the S-Video plug on the other end of the USB cable to an external screen
- ▶ Activate **Video-out**

BLUETOOTH -

A connection to the Leica Calonox app can be established if the Bluetooth function is activated (see p. 30).

“FOG AND RAIN” MODE -

In this mode, image contrast can be improved (useful in cloudy, rainy, foggy and other rough weather conditions).

Note

- Power consumption increases in “Fog and rain” mode, which will reduce battery life accordingly.

HANDHELD MODE -

In standard operation, the screen image is designed to be viewed through a scope with relevant magnification. When used as a handheld device, this option allows larger scaling.

Note

- Handheld mode must be deactivated if the device is used as an accessory mount.

USER PROFILES -

Here we have the option of creating profiles for up to 4 different rifle scopes or rifles, so that the rifle scope will not have to be set each time. The profiles **G1** & **G2** are suitable for rifle scopes with a large field of view. The profiles **G3** & **G4** are suitable for rifle scopes with a smaller field of view.

- ▶ Select **Gun Profile** in the list menu
- ▶ Select a profile

Note

- The position of the screen section may have to be adjusted (see p. 28).

CORRECTING PIXEL ERRORS -

Pixel errors may occur on the screen from time to time. These can be selected and corrected using a special mode.

Accessing the pixel correction mode

- ▶ Select **Pixels defect correction** in the list menu
 - A cross-hair pointer appears in the screen image to indicate the current position, and operating instructions are displayed in the header line.

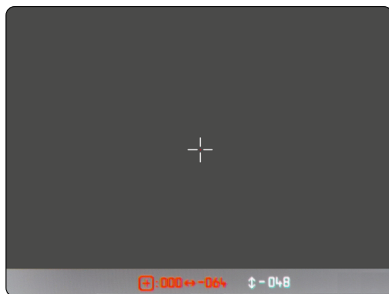

Selecting a faulty pixel

- ▶ Place the cross-hair pointer directly over the faulty pixel

Controlling the cross-hair pointer	
Select an active axis/ switch between X and Y axis	Press the menu selection button <u>briefly</u>
To the right/up	Press the [+] button <u>briefly</u>
To the left/down	Press the [-] button <u>briefly</u>
To the right/up (quick)	<u>Press and hold</u> the [+] button
To the left/down (quick)	<u>Press and hold</u> the [-] button

Marking defective pixels

- ▶ Press and hold the **[+]** and **[-]** button simultaneously
 - A status bar with the number of marked pixels appears in the status bar for confirmation.

Storing marked pixels

- ▶ Press and hold the menu selection button
 - A menu to save the pixels or to exit the mode will appear.

CORRECTING THE RETICLE -

The display section (Clip-on mode) for the reticle of the rifle scope must be shifted to align Calonox Sight with the point of impact.

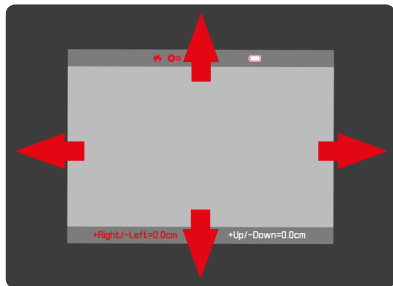

Accessing reticle correction

- ▶ Select **Reticle correction** in the list menu
 - The reticle correction mode appears.

Making the correction

- ▶ Move the display section so that the point of impact of the rifle with the rifle scope matches the point of impact of the rifle with rifle scope and Calonox Sight.

Attention

- Determine and correct the point of impact exclusively on the shooting range with live ammunition.

Controls

Select an active axis/ switch between X and Y axis	Press the menu selection button <u>briefly</u>
To the right/up	Press the [+] button <u>briefly</u>
To the left/down	Press the [-] button <u>briefly</u>
To the right/up (quick)	<u>Press and hold</u> the [+] button
To the left/down (quick)	<u>Press and hold</u> the [-] button
Exit	<u>Press and hold</u> the menu selection button
Save	<u>Press and hold</u> the [+] button The device switches off.

SHOW SYSTEM INFORMATION -

Various types of device information are available under the menu item **System information**.

RESET TO FACTORY SETTINGS -

You can delete all manual settings and reset them to their factory settings. All stored user profiles will be deleted.

- ▶ Select **Factory reset** in the list menu

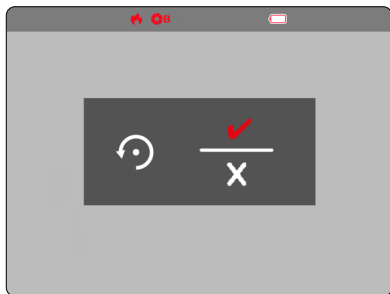

Confirming the procedure

- ▶ Press the menu selection button
 - The device will be reset.

Canceling the procedure

- ▶ Press the **[-]** button
 - The list menu appears.

Attention

- Review your settings and zero the device again at a shooting range after a **factory reset**.

PROCEDURE IN CASE OF MALFUNCTION

Should the device no longer function as described, it can be switched off using a key combination. All functions should return to normal after the device is switched on again.

- ▶ Press and hold the **[+]** and **[-]** buttons simultaneously for about 30–60s
 - The device switches off.
- ▶ Switch the device on again (see p. 19)

LEICA CALONOX APP

The device can be remotely controlled via smartphone or tablet. That will require the installation of the “Leica Calonox Sight” app on the mobile device. A list of available functions and instructions for their use can be found in the app.

- ▶ The app is available from Apple App Store™ /Google Play Store™ for download and installation

CONNECTION

ESTABLISHING A CONNECTION

ON THE DEVICE

- ▶ Press and hold the menu selection button
 - The list menu appears.
- ▶ Select **Bluetooth**
- ▶ Press the menu selection button briefly
 - Bluetooth® is activated (✱ appears).

Note

- The Bluetooth function is deactivated automatically if no connection is established within one minute.

Attention

- Do not attempt to change device settings while using the app. Doing so could cause conflicts and technical issues.

ON THE MOBILE DEVICE

- ▶ Activate Bluetooth®
- ▶ Launch the Leica Calonox app
- ▶ Tap "Connect Device"
- ▶ Tap the button with the magnifying glass icon
 - A list of devices appears
- ▶ Select the desired device
 - A connection is established.

DISCONNECTION

We recommend disabling the Bluetooth function, once a connection to the mobile device is no longer needed.

- ▶ Press and hold the menu selection button
 - The list menu appears.
- ▶ Select **Bluetooth**
- ▶ Press the menu selection button briefly
 - Bluetooth® is deactivated and the connection is dropped.

Note

- Power consumption increases while the device is connected to the app, which will reduce battery life accordingly.

CARE/CLEANING

- Your Leica product requires no special care.
- Coarse dirt particles like sand can be removed with a soft brush or simply blown off.
- Fingerprints, etc. on front lenses and eyepiece lenses can be pre-cleaned with a damp cloth and then wiped dry with a clean leather or lint-free cloth.
- The device should be stored in a well-ventilated, dry and cool place to prevent fungal growth (particularly important in humid climates).
- Do not use alcohol or chemical cleaning solutions on the optics or housing.
- Do not use excessive force when cleaning a severely soiled lens surface. The coating is abrasion resistant, but not impervious to sand or salt crystals.
- The housing should be cleaned using a damp leather cloth only. Using a dry cloth may cause friction, which may result in a static discharge.
- Always rinse off any traces of salt water! Dried salt crystals could damage the surfaces.

TECHNICAL DATA

Designation	Leica Calonox Sight
Device type	Thermal imaging device
Type No.	1790
Order No.	50500
Scope of delivery	Calonox Sight, cordura case, charging cable, carry strap, quick start guide, lens cleaning cloth, rubber eyecup, certificate
Sensor type	VOx
Sensor size	384 x 288 pixels
Pixel size	17 µm
Screen type	OLED
Screen diagonal	0.39"
Screen resolution	1024 x 768 pixels
Image repetition frequency	50 Hz
Lens focal length	42 mm
Optical basic magnification	1x
Digital Zoom	-
Field of view	8.9 x 6.7° (15.5 m x 11.7 m/100 m)
Diopter compensation	-
Range/Resolution (calculated for image subject 1.7 m x 0.5 m)	
Detection range / Resolution	2000 m/2 pixels
Recognition range / Resolution	700 m/6 pixels
Identification range / Resolution	350 m/12 pixels

Adjustment reticle correction	1.2 cm/50 m, 2.4 cm/100 m
Video output	PAL
Video recording	-
Video/Picture resolution	-
Cable socket	USB-C
Wireless connection	Bluetooth®
Internal memory	-
Protection type	IP67
Operating temperature	-20°C to +50°C
Operating temperature (charge battery)	+10 to +30°C
Battery life	approx. 8 - 11 h
Accessory thread	M52x0.75
Tripod thread	A ¼ DIN 4503 (¼"), M5 standard thread
Material	Plastic with rubber armoring
Dimensions (WxH)	165 x 65 mm
Weight (with battery)	685 g

Subject to changes in design, production, and scope of delivery.

LEICA CUSTOMER CARE

Please contact Leica Camera AG Customer Care for the maintenance of your Leica equipment and for help and advice regarding Leica products and how to order them. You can also contact the Customer Care department or the repair service provided by your regional Leica subsidiary for repairs or warranty claims.

Leica Camera AG

Leica Customer Care
Am Leitz-Park 5
35578 Wetzlar
Germany

Phone: +49 (0)6441 2080-189

Fax: +49 (0)6441 2080-339

Email: customer.care@leica-camera.com

www.leica-camera.com