



LEICA SL2

QUICK START GUIDE



Download the full scope instruction manual here:

<https://en.leica-camera.com/Service-Support/Support/Downloads>

Please register via the following link if you would like to receive a printed copy of the full scope instruction manual:

www.order-instructions.leica-camera.com

PART DESIGNATIONS

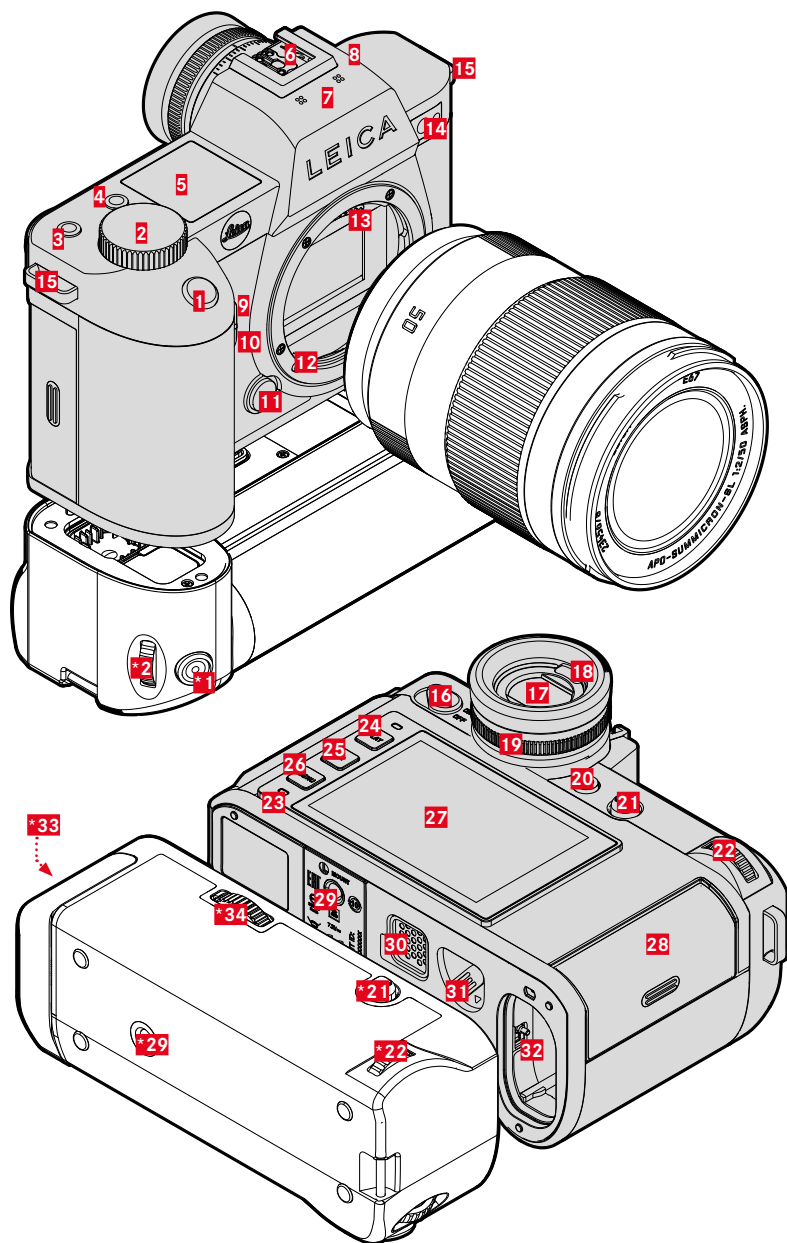

* optional accessory: Multifunction hand grip SL

1 Shutter button

Tap:

- Autofocusing
- Activating exposure metering and exposure control

Press down fully:

- Shutter release
- Video recording Start/Stop

in standby mode:

- The camera is reactivated

2 Front setting wheel

in the menu:

- Scrolling through the menu screens

in recording mode:

- depending on exposure mode, configurable (see table under "Wheel assignment")

in review mode:

- Zooming in/out of the frame

3 FN button**

in recording mode:

- Photo: **ISO**
- Video: **ISO** (Cine: **Exposure Index**)

4 FN button**

in recording mode:

- Mode change photo/video

in review mode:

- Marking/rating a recording

5 Top display

- Set operating mode
- Recording data
- Camera information

6 Accessory shoe

Recommended flash units:

Leica SF 40, SF 64 and SF 58

7 Microphone

Sound is recorded in stereo

8 Speaker

9 FN button**

in recording mode:

- Photo: **Magnification**
- Video: **Microphone Gain**

10 FN button**

in recording mode:

- Setting the AF metering method

11 Lens release button

12 Leica L bayonet

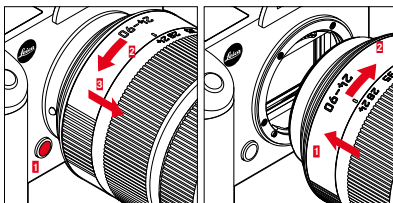

13 Contact strip

14 Self-timer LED / AF Assist Lamp / Sensor for exposure metering

15 Strap lugs

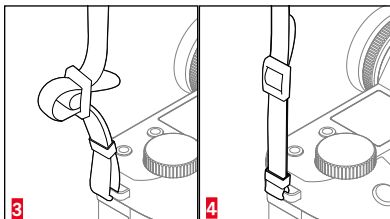
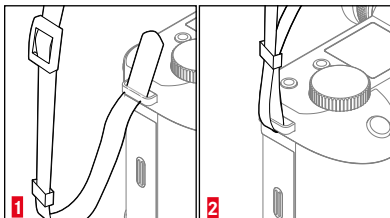

16 Main switch

Switching the camera ON/OFF

17 Viewfinder eyepiece

18 Eye sensor

Available settings: LCD panel only/EVF only/automatic switchover

19 Diopter setting ring

Setting range: -4/+2 diopter

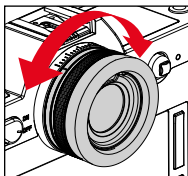

** Factory settings. Press & release: Call-up of assigned function. Press & hold: Modify assignment (drop-down list).

20 FN button**

EVF/LCD panel switchover

21 Joystick

in the menu:

- Menu control

in recording mode:

- Shifting the AF metering field
- Exposure lock (press and hold)

in review mode:

- Scrolling
- Video playback control

22 Thumbwheel

in the menu:

- Menu control

in recording mode:

- depending on exposure mode, configurable (see table under "Wheel assignment")

in review mode:

- Scrolling
- Video playback control

23 Status LED

- Memory card access
- Using the WLAN function
- Charging via USB

24 PLAY button

- Switchover between picture and playback/review mode
- Return to full-screen display

25 FN button**

in Playback/Review mode:

- Toggling info displays

26 MENU button

in the menu:

- Scrolling through the menu screens

in recording mode:

- Accessing the menu

in review mode:

- Accessing the Playback/Review menu

27 LCD panel



3.2" TFT LCD, 1080 x 720 pixels, 2,332,800 dots, touch panel

28 Memory card slot

UHS-II, UHS-I, SD/SDHC/SDXC

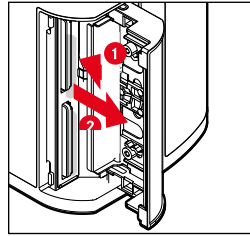

29 Tripod thread

A 1/4 DIN 4503 (1/4") with stainless steel in the base

30 Contact for multifunction hand grip

31 Battery release lever

32 Battery compartment

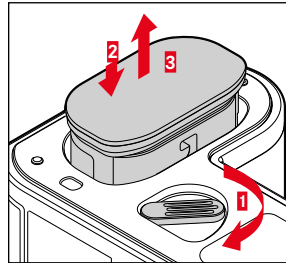

*33 Hand grip-integrated battery compartment

*34 Hand grip lock

CHARGING THE BATTERY

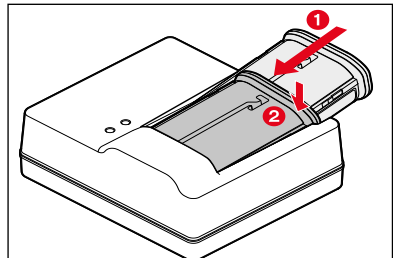

Display	Charge status	Charge time*
CHARGE flashes green	battery is charging	
80% lights up orange	80%	approx. 2 h
CHARGE continuous green light	100%	approx. 3½ h

*for a completely discharged battery

ATTACHING THE MULTIFUNCTION HAND GRIP*

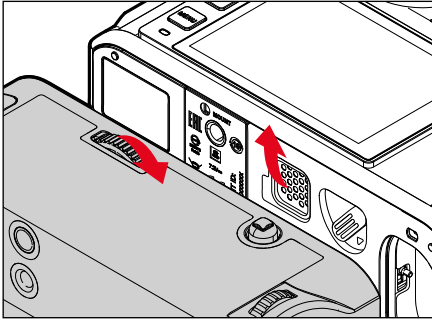

LOAD USB/DATA TRANSFER

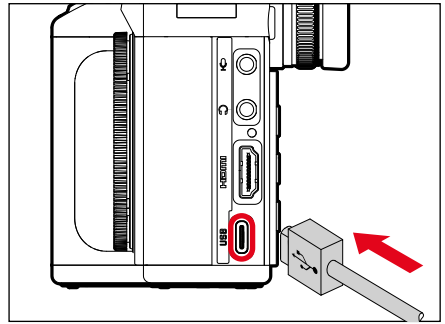

STATUS DISPLAY PHOTO



- 01 Focal length
- 02 Memory card used
- 03 Remaining memory capacity
- 04 Battery capacity
- 05 Menu section **PHOTO**
- 06 Menu sections **VIDEO**
- 07 Light balance
- 08 Exposure compensation scale
- 09 Exposure mode
- 10 Exposure value
- 11 Shutter speed
- 12 ISO Sensitivity
- 13 Exposure compensation VALUE
- 14 Picture mode (Picture sequence)
- 15 Autofocus mode

STATUS DISPLAY VIDEO

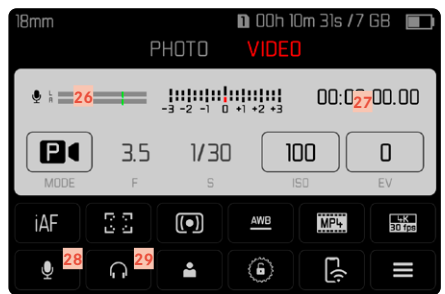

- 16 Autofocus metering method
- 17 Autofocus settings
- 18 Exposure metering method
- 19 White balance mode
- 20 File format/compression level/resolution
- 21 Formatting a memory card
- 22 User profile
- 23 Locking/unlocking the setting wheels
- 24 Leica FOTOS
- 25 Main menu
- 26 Microphone recording level
- 27 Recording time
- 28 Recording level
- 29 Headphone volume

INITIAL START/APP CONNECTION

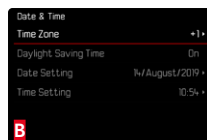
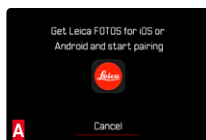

SWITCHOVER: PHOTO/VIDEO

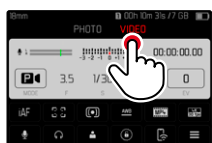
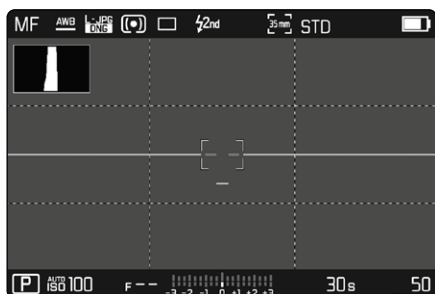

GESTURE CONTROL

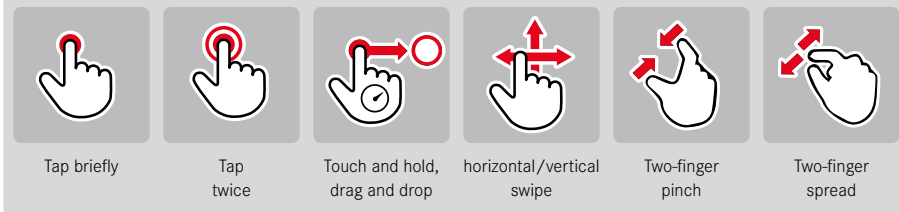

WHEEL ASSIGNMENT (factory settings)

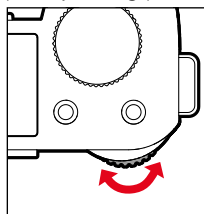

Thumbwheel

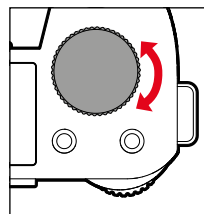

Front setting wheel

Function assignment optionally for thumbwheel or front setting wheel

AF lens	P	Program shift	Exposure Compensation
		Exposure Compensation	Microphone Gain
	S/S	Exposure Compensation	Shutter speed
	A/A	Aperture	Exposure Compensation
	M/M		Shutter speed
MF lens	A	Magnification	Exposure Compensation
		Magnification	Exposure Compensation
	M/M	Magnification	Shutter speed

The function assignment can be switched between the two wheels.

- ▶ Select **Direct Access Settings** in the main menu
- ▶ Select **Wheel Assignment (AF Lenses)** / **Wheel Assignment (MF Lenses)** in the submenu
- ▶ Select the desired setting

LEICA FOTOS APP

Experience the new Leica FOTOS app. The Leica FOTOS app is a digital tool with plenty of exciting options and allows the photographer to get more out of his Leica camera than ever before. You can now link all your WLAN-capable Leica cameras via a single app to transfer images easily and instantly, capture the essence of unforgettable moments, manage, optimize and share your photos – anytime, anywhere.



SAFETY REMARKS

GENERAL INFORMATION

- Do not use your camera in the immediate vicinity of devices with powerful magnetic, electrostatic or electromagnetic fields (e.g. induction ovens, microwave ovens, television sets or computer monitors, video game consoles, cell phones, broadcasting equipment). Their electromagnetic fields can interfere with recordings.
- Strong magnetic fields, e.g. from speakers or large electric motors can damage the stored picture data or disrupt recording.
- Switch off the camera, remove the battery and switch the camera back on in case of a camera malfunction due to the effects of electromagnetic fields.
- Do not use the camera in the immediate vicinity of radio transmitters or high-voltage power lines. Their electromagnetic fields may interfere with recordings.
- Always store small parts e.g. the accessory shoe cover as follows:
 - out of the reach of children
 - in a safe location, where they will not get lost or stolen
- State-of-the-art electronic components are sensitive to static discharge. Since people can easily pick up charges of several 10,000 volts by walking on synthetic carpets, a discharge can occur when you touch the camera, and especially it is placed on a conductive surface. A static discharge on the camera housing poses no risk for the electronics. Despite built-in safety circuits, you should avoid direct contact with external camera contacts like those in the flash shoe.
- Take care not to soil or scratch the sensor for lens detection (6-bit encoding) in the bayonet. You must similarly prevent direct contact of the bayonet with grains of sand or similar particles, as these could cause irreparable damage. This component must only be cleaned with a dry cloth (in system cameras).
- Use a cotton or linen cloth instead of a microfiber cloth from an optician's (synthetic) when cleaning the contacts. Make sure to discharge any electrostatic charge by deliberately touching a heating or water pipe (conductive, grounded material). Dirt deposits and oxidation on the contacts can be avoided by storing your camera in a dry location with the lens cap and the flash shoe/viewfinder cap (in system cameras) attached.
- Only use accessories specified for this model to prevent faults, short circuits or electric shock.
- Do not attempt to remove parts of the housing (covers) yourself. Repairs must be done at authorized service centers only.
- Protect the camera against contact with insect sprays and other aggressive chemicals. Petroleum spirit, thinner and alcohol must not be used for cleaning. Some chemicals and liquids can damage the camera housing or the surface finish.
- Rubber and plastics are known to expel aggressive chemicals and should therefore not be kept in contact with the camera for extended periods of time.
- Prevent any sand or dust or water penetration into the camera, e.g. during snowfall or rain or on the beach. Be extra careful when changing the lens (in system cameras) and when inserting or removing the memory card and rechargeable battery. Sand and dust can damage the camera, the lens, the memory card and the battery. Moisture can cause malfunctions and irreparable damage to the camera and memory card.

LENS

- A camera lens can have the effect of a magnifying glass when exposed to direct frontal sunlight. The camera must therefore be protected against extended exposure to direct sunlight.
- Attaching the lens cap and keeping the camera in the shade or ideally in its camera case, will help prevent damage to the interior of the camera.

RECHARGEABLE BATTERY

- Improper use of the batteries or the use of unapproved battery types may result in an explosion!
- Do not expose the rechargeable battery to sunlight, heat, humidity or moisture for prolonged periods of time. Likewise, the batteries must not be placed in a microwave oven or a high-pressure container as this would pose a fire or explosion hazard.
- Do not under any circumstances charge or insert a damp or wet battery into the camera!
- A safety valve in the battery ensures that any excess pressure caused by improper handling is discharged safely. It is nevertheless important to dispose of a bloated battery immediately. It may pose an explosion hazard!
- Keep the battery contacts clean and easily accessible. Although lithium-ion batteries are secured against short circuits, they should still be protected against contact with metal objects like paper clips or jewelry. A short-circuited battery can get very hot and cause severe burns.
- When a battery is accidentally dropped, make sure to check the housing and the contacts immediately for any damage. A damaged battery can damage the camera.
- The battery must be removed from the camera or charger and must be replaced immediately in case of a strange smell, discoloration, deformation, overheating or leakage. Continued use of the battery may result in overheating, which can cause fire and/or explosion!
- Never throw batteries into a fire as they might explode!
- Keep the battery away from sources of heat in case of a leak or a smell of burning. Leaked fluid can catch fire!

- The use of other chargers not approved by Leica Camera AG can cause damage to the batteries – and in extreme cases – cause serious or life-threatening injuries.
- Make sure that the power socket is freely accessible at all times.
- The in-car charging cable must never be connected while the charger is connected to mains electricity.
- Do not attempt to open the battery or the charger. Repairs must only be carried out by authorized service centers.
- Keep batteries out of the reach of children. Batteries can cause suffocation when swallowed.

CHARGER

- Using the charger in the vicinity of broadcasting receivers may interfere with reception. Ensure a distance of at least 1 m (3 ft) between the charger and the receiver.
- When the charger is in use, it may emit a buzzing sound – this is normal and not a malfunction.
- Disconnect the charger from the mains when it is not in use, because it consumes some a very small amount electricity, even when no battery is inserted.
- Always keep the charger contacts clean, and never short circuit them.

MEMORY CARD

- Never remove the memory card during a datasave or card reading process. The camera must not be switched off or be subjected to impact or vibrations while working.
- Do not open the compartment or remove the memory card or battery while the status LED is flashing to indicate camera memory access. Data on the card may otherwise be destroyed and camera malfunctions may occur.
- Do not drop or bend memory cards as this will cause damage and result in the loss of stored data.
- Do not touch the connections on the reverse of the memory card and keep them clean and dry.
- Keep memory cards out of the reach of children. Swallowing a memory card may cause suffocation.

SENSOR

Cosmic radiation (e.g. during flights) may cause pixel defects.

CARRY STRAP

- Once you have attached the carry strap, please make sure that the clips are mounted correctly to prevent the camera from falling.
- Carry straps are usually made of very robust material. You should therefore keep it out of the reach of children. A carry strap is not a toy and poses a strangulation risk.
- Use the carry strap only for its intended purpose on a camera or on binoculars. Any other use poses the risk of injury and may possibly result in damage to the carry strap and is therefore not permitted.
- Carry straps should also not be used for cameras/binoculars during sports activities with a high risk of getting entangled in the carry strap (e.g. mountain climbing and similar outdoor activities).

TRIPOD

- When using a tripod, make sure it is standing securely and turn the camera only by turning the tripod, not the actual camera.
- Ensure that the tripod screw is hand-tightened only.
- Avoid transporting the camera while the tripod is attached. You might injure yourself or others and the camera could get damaged.



FLASH

The use of incompatible flash units with your Leica SL2 may result in irreparable damage to the camera and/or the flash unit.

REGULATORY INFORMATION

Specific regional approvals for this device can be found in the camera menu.

- ▶ Select **Camera Information** in the main menu
- ▶ Select **Regulatory Information** from the submenu

 Alternating current (AC)  Direct current (DC)	 Class II devices (the product has a double-insulated design)
---	--



DISPOSAL OF ELECTRICAL AND ELECTRONIC EQUIPMENT

(Applies within the EU and for other European countries with active waste separation policies)

This device contains electric and/or electronic components which must not be disposed of in general household waste. Instead, it should be disposed of at a recycling collection point provided by your local authority. This service is free of charge. Any standard or rechargeable batteries used in this device must be removed and disposed of separately in accordance with local regulations. Please contact your local authorities, waste disposal collection point or the retailer, from whom you purchased the device for more information on correct waste disposal.

English

Declaration of Conformity (DoC)

Hereby, "Leica Camera AG" declares that this product is in compliance with the essential requirements and other relevant provisions of Directive 2014/53/EU.

Customers can download a copy of the original DoC to our RE products from our DoC server:

www.cert.leica-camera.com

In case of further questions, please contact:

Leica Camera AG, Am Leitz-Park 5, 35578 Wetzlar, Germany

Product dependent (see technical data)

Type	Frequency band (central frequency)	Maximum power (dBm e.i.r.p.)
WLAN	2412-2462/5180-5240 MHz/	20
	5260-5320/5500-5700 MHz	
Bluetooth® Wireless Technology	2402-2480 MHz	20

The CE mark on our products documents compliance with the fundamental requirements of applicable EU guidelines.

WLAN: 5150 to 5350 Mhz for indoor use only

WARRANTY

In addition to your statutory warranty rights regarding your dealer, you will receive an additional Leica Camera AG product warranty valid from the date of purchase at an authorized Leica retailer. Previously, the product warranty was included with the product in the packaging. From now on, the product warranty will only be available online as a new service. You will be able to review the warranty conditions for your product at any time, without having to search for the document. Please note that this new policy applies only for products that are no longer delivered with a hardcopy product warranty included in the packaging. Any products still delivered with the warranty document in the packaging remain governed exclusively by that document. For more information regarding the warranty scope, services and limitations, please visit: warranty.leica-camera.com

FOR US ONLY:

FCC Note:

This equipment has been tested and found to comply with the limits for a Class B digital device, pursuant to Part 15 of the FCC Rules. These limits are designed to provide reasonable protection against harmful interference in a residential installation. This equipment generates, uses, and can radiate radio frequency energy and, if not installed and used in accordance with the instructions, may cause harmful interference to radio communications. However, there is no guarantee that interference will not occur in a particular installation. If this equipment does cause harmful interference to radio or television reception, which can be determined by turning the equipment off and on, the user is encouraged to try to correct the interference by one or more of the following measures:

- Reorient or relocate the receiving antenna.
- Increase the separation between the equipment and receiver.
- Connect the equipment into an outlet on a circuit different from that to which the receiver is connected.
- Consult the dealer or an experienced radio/TV technician for help.

FCC Caution:

To assure continued compliance, follow the attached installation instructions and use only shielded interface cables with ferrite core when connecting to computer or peripheral devices. Any changes or modifications not expressly approved by the party responsible for compliance could void the user's authority to operate this equipment.

Trade Name:	LEICA
Type No.	2998
Responsible party/ Support contact:	Leica Camera Inc. 1 Pearl Count, Unit A, Allendale, New Jersey 07401 Tel.: +1 201 995 0051 / Fax: +1 201 995 1684 technicalinfo@leicacamerausa.com

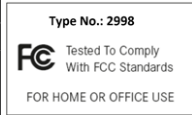
**Contains FCC ID: VPYLB1JS955**

This transmitter must not be co-located or operated in conjunction with any other antenna or transmitter. This equipment complies with FCC radiation exposure limits set forth for an uncontrolled environment and meets the FCC radio frequency (RF) Exposure Guidelines. This equipment has very low levels of RF energy that are deemed to comply without testing of specific absorption ratio (SAR).

FOR CANADA ONLY:

CAN ICES-3 (B)/NMB-3(B)
HMN: 2998
Contains IC: 772C-LB1JS955



A recyclable lithium ion/polymer battery powers this camera. Please call 1-800-8-BATTERY for information on how to recycle this battery.

This device complies with Industry Canada licence-exempt RSS standard(s). Operation is subject to the following two conditions:

- (1) this device may not cause interference, and
- (2) this device must accept any interference, including interference that may cause undesired operation of the device.

The available scientific evidence does not show that any health problems are associated with using low power wireless devices. There is no proof, however, that these low power wireless devices are absolutely safe. Low power Wireless devices emit low levels of radio frequency energy (RF) in the microwave range while being used. Whereas high levels of RF can produce health effects (by heating tissue), exposure of low-level RF that does not produce heating effects causes no known adverse health effects. Many studies of low-level RF exposures have not found any biological effects. Some studies have suggested that some biological effects might occur, but such findings have not been confirmed by additional research. Model 4889 has been tested and found to comply with IC radiation exposure limits set forth for an uncontrolled environment and meets RSS-102 of the IC radio frequency (RF) Exposure rules.

FOR SINGAPORE ONLY

<p>Complies with IMDA Standards DA106734</p>
--

FOR UNITED ARAB EMIRATES ONLY:

<p>TRA REGISTERED No: ER73893/19 DEALER No: DA0112968/13</p>
--

Covered by one or more claims of the HEVC patents listed at patentlist.accessadvance.com.

TECHNICAL DATA

CAMERA

Designation

Leica SL2

Camera type

Mirrorless full-frame system camera

Type no.

2998

Order No.

10 854 EU/JP/US (black), 10 856 ROW (black)

Buffer memory

4 GB

DNG™: 78 recordings

JPG: > 100 recordings

Storage medium

UHS-II (recommended), UHS-I, SD/SDHC/SDXC memory card

Material

Full-metal housing made of aluminum and magnesium, leatherette cover, splash-water protected in compliance with IEC standard 60529 (protection type IP54).

Lens mount

Leica L bayonet with contact strip for communication between lens and camera

Operating conditions

-10 to +40°C

Rated input voltage / current

DC 7.2V, 1.9A (continuous)

Dimensions (WxHxD)

146 x 107 x 42 mm

Weight

approx. 835 g (without battery)

SENSOR

Sensor size

CMOS sensor, pixel pitch: 4.3 µm

Fullframe (47.3 MP): 8368 x 5584 pixels

APS-C (20.2 MP): 5504 x 3664 pixels

Picture resolution

DNG™: 8368 x 5584 pixels (46.7 MP)

JPG: 8368 x 5584 pixels (46.7 MP), 6000 x 4000 pixels (24 MP), 4272 x 2848 pixels (12 MP)

VIEWFINDER/LCD PANEL

Viewfinder (EVF)

Resolution: 5,760,000 pixels (dots), 120 fps, magnification: 0.78x, aspect ratio: 4:3, frame coverage: 100%, exit pupil position: 21 mm, setting range +2/-4 diopters, with eye sensor for automatic switchover between viewfinder and LCD panel, time delay 0.005 s

LCD panel

3.2" (backlight LED) with anti-fingerprint and anti-scratch coating, 2,100,000 pixels (dots), format 3:2, touch control available

EQUIPMENT

WLAN

The Leica FOTOS app is required to use the WLAN function. The Leica app is available from the Apple App Store™ or the Google Play Store™. Complies with Wi-Fi IEEE802.11b/g/n, 2.4 GHz, channel 1-11 (2412-2462 MHz) and Wi-Fi IEEE802.11ac, 2.4 GHz & 5 GHz, channel 39-48 (5180-5240 MHz), channel 52-64 (5260-5320 MHz), channel 100-140 (5500-5700 MHz) (standard WLAN protocol), encryption method: WLAN-compatible WPA™/WPA2™

Bluetooth

Bluetooth v4.2 (Bluetooth Low Energy (BLE)), 2402 to 2480 MHz

Menu languages

English, German, French, Italian, Spanish, Russian, Japanese, Simplified Chinese, Traditional Chinese, Korean

POWER SUPPLY

Rechargeable battery (Leica BP-SCL4)

Lithium-ion rechargeable battery, rated voltage: 7.2 V (DC); capacity: 1860 mAh (min.), approx. 370 recordings (based on CIPA standard, without EVF); charging time: approx. 140 min (after deep discharge); manufacturer: Panasonic Energy (Wuxi) Co. Ltd., Made in China

Charger (Leica BC-SCL4)

Input: AC 100-240 V, 50/60 Hz, 0.25 A, automatic switchover; Output: DC 8.4 V 0.85 A; Manufacturer: Salom Electric (Xiamen) Co., Ltd., Made in China

You will find the manufacturing date of your camera on the stickers in the Warranty Card and/or on the packaging. The date format is year/month/day. Subject to changes in design and production.